

Article number: 3902150023555

Description: Worm gear
VF 150-FC1-23-160B5, without lubrication

Measures

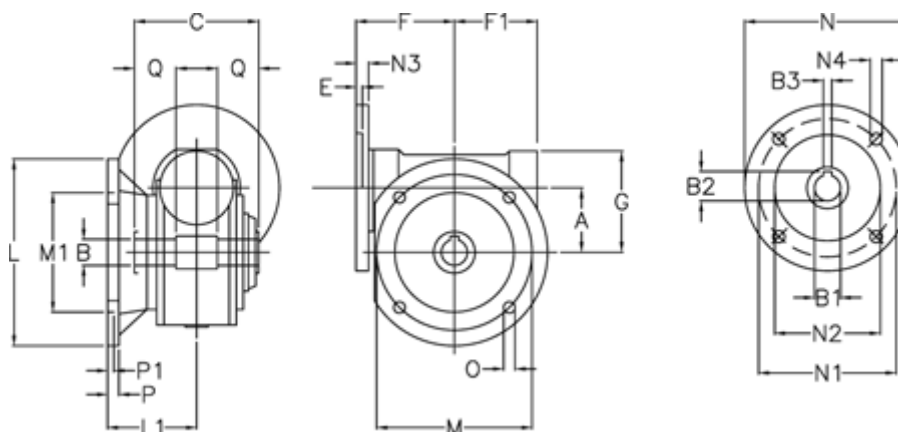

A	= 150	F1	= 179	N2	= 250
B	= 50 H7	G	= 218	N3	= 18
B1 E7	= 42	L	= 350	N4	= 18
B2	= 44.6	L1	= 145.5	O	= 18
B3 H9	= 12	M	= 290	P	= 22
C	= 175	M1	= 200	P1	= 13
E	= 2	N	= 350	Q	= 55
F	= 190	N1	= 300		